

# Syncrowave® 300

TIG/Stick Welding Power Source 

## Quick Specs



### Industrial Applications

Precision metal fabrication  
Maintenance and repair  
Light and heavy manufacturing  
Shipbuilding  
Tube and pipe  
Automotive  
Vocational

### Processes

TIG (GTAW)  
Stick (SMAW)  
DC pulsed TIG (GTAW-P)

### Input Power

208/240/480 V,  
1-phase or 3-phase power

**Amperage Range** 5–300 A

**Max. Open-Circuit Voltage** 60 VDC

**Rated Output** 300 A at 22 V, 30% duty cycle  
210 A at 18 V, 60% duty cycle

### Net Weight

**Machine only:** 101 lb. (45.8 kg)  
**With Cooler and Running Gear:** 176.4 lb. (80 kg)

**Auto-Link®** circuit automatically links the power source to primary voltage being applied (208/240/480 V, single- or three-phase).

**Simple to install.** Accepts either single- or three-phase input power.

**Internal cooler power supply** runs the Coolmate™ 3 off of the input power and requires no additional hook up.

**Smaller footprint and lightweight design** make it easier to install and maneuver.

**Easy to use.** Intuitive user interface is simple to understand making it easy to adjust parameters, and means less time training new employees and more time getting work done.

**Pro-Set™** button gets to factory preset parameters with one touch of a button.

**Energy efficient.** Save up to 33 percent on energy costs versus outdated welding equipment.

**More stable arc and better arc starts** versus outdated welding equipment.



### AC TIG Features

**Balance** control provides adjustable oxide removal which is essential for creating the highest quality aluminum welds.

### DC TIG Features

**Pulse.** Pulsing can increase puddle agitation, arc stability and travel speeds while reducing heat input and distortion.

### DC Stick Features

**DIG** control allows the arc characteristics to be changed for specific applications and electrodes. Lower the DIG setting for smooth running electrodes like E7018 and increase the DIG setting for stiffer, more penetrating electrodes like E6010.

**Hot Start™** adaptive control provides positive arc starts without sticking.



Power source is warranted for three years, parts and labor.



**Miller Electric Mfg. LLC**  
An ITW Welding Company  
1635 West Spencer Street  
P.O. Box 1079  
Appleton, WI 54912-1079 USA

**Equipment Sales US and Canada**  
Phone: 866-931-9730  
FAX: 800-637-2315  
International Phone: 920-735-4554  
International FAX: 920-735-4125

**MillerWelds.com**



## Additional Features

**Fan-On-Demand™** power source cooling system operates only when needed, reducing noise, energy use and the amount of contaminants pulled through the machine.

**Wind Tunnel Technology™** protects internal electrical components from airborne contaminants, extending the product life.

**Coolmate™ 3 cooler** (Complete packages only). Three-gallon cooling system equipped with a visual flow indicator ensures that the coolant is flowing. An external coolant filter stops foreign objects from entering the water-cooled torch cable for better flow and longer life. Extended cooling capacity ensures maximum productivity. Three-year cooler warranty.

**Arc timer/cycle counter** records actual welding time and number of arc starts. Great for estimating job costs.

**Welding aluminum?** Oxides that form on aluminum melt at temperatures over 3700 degrees Fahrenheit. The aluminum material that is located under this layer of oxide melts at 1200 degrees Fahrenheit. The **AC squarewave welding current** of the Syncrowave 300 automatically removes the layer of oxide which is necessary for producing high-quality welds.

### Do you have power fluctuations?

The Syncrowave 300 compensates for power fluctuation without changing your welding parameters. **Line voltage compensation** works on fluctuating power  $\pm 10$  percent.

**Easy-load cylinder rack** minimizes cylinder lifting. Cylinder is not included.

**Lift-Arc™** provides AC or DC arc initiation without the use of high frequency.

**Blue Lightning™** high-frequency (HF) arc starter for non-contact arc initiation. Provides more consistent arc starts and greater reliability compared to traditional HF arc starters.

**Auto-postflow** adjusts the length of postflow time based on the amperage setting, shielding your tungsten and eliminating the need to set the postflow time.

## AC Output: Balance Control

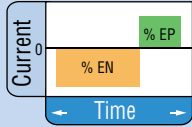
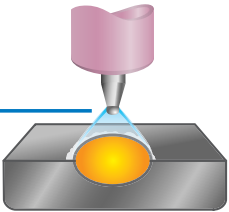
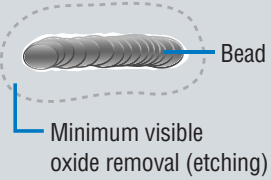
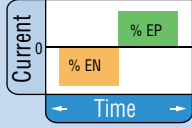
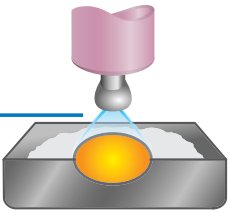
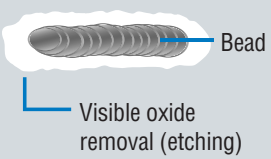
Feature	Setting	Arc Effect	Weld Effect
<p><b>AC Balance Control</b></p> <p>Controls arc cleaning action. Adjusting the % EN of the AC wave controls the width of the etching zone surrounding the weld.</p> <p><i>Note: Set the AC Balance control for adequate arc cleaning (etching) action at the sides and in front of the weld puddle. AC Balance should be fine-tuned according to the amount of etching desired.</i></p> <p>Balance range: Ball, 60–80% Pro-Set™ setting: 68%</p>	<p><b>75% EN</b></p> 	<p>Reduces balling action and helps maintain point</p> 	 <p>Minimum visible oxide removal (etching)</p>
	<p><b>60% EN</b></p> 	<p>Increases balling action of the electrode</p> 	 <p>Visible oxide removal (etching)</p>

# Specifications (Subject to change without notice.)



Welding Process	Input Power	Welding Amperage Range	Rated Output	Amps Input at Rated Load Output, 50/60 Hz					Max. Open-Circuit Voltage	Dimensions	Net Weight
				208 V	240 V	480 V	KVA	KW			
TIG* (GTAW)	1-phase	5-300 A	300 A at 22 V, 30% duty cycle	47	41	19	9.7	9.4	60 VDC (13 VDC**)	<b>Power Source</b> H: 29.4 in. (746 mm) W: 15 in. (381 mm) D: 24.6 in. (625 mm)  <b>With Cooler and Running Gear</b> H: 43.9 in. (1114 mm) W: 20.5 in. (521 mm) D: 36.3 in. (921 mm)	<b>Power Source</b> 101 lb. (45.8 kg)  <b>With Cooler and Running Gear</b> 176.4 lb. (80 kg)
	3-phase			27	23	11	9.7	9.2			
	1-phase	5-300 A	210 A at 18.4 V, 60% duty cycle	27	24	12	5.7	5.5			
	3-phase			16	14	7	5.9	5.5			
	1-phase	5-300 A	175 A at 17 V, 100% duty cycle	13	11	6	4.8	4.3			
	3-phase			13	11	6	4.8	4.3			
Stick (SMAW)	1-phase	5-230 A	230 A at 28.4 V, 30% duty cycle	44	37	18	9	8.8	60 VDC (13 VDC**)		
	3-phase			25	22	11	8.9	8.6			
	1-phase	5-230 A	160 A at 26.4 V, 60% duty cycle	27	23	11	5.7	5.5			
	3-phase			16	11	5	5.7	5.5			
	1-phase	5-230 A	125 A at 25 V, 100% duty cycle	20	18	9	4.2	4.1			
	3-phase			12	10	5	4.3	4.2			

\*Includes cooler power draw. \*\*Indicates sense-voltage for Lift-Arc™ TIG and Low OCV stick.

Certified by Canadian Standards Association to both the Canadian and U.S. Standards.

## Performance Data

Duty Cycle Chart

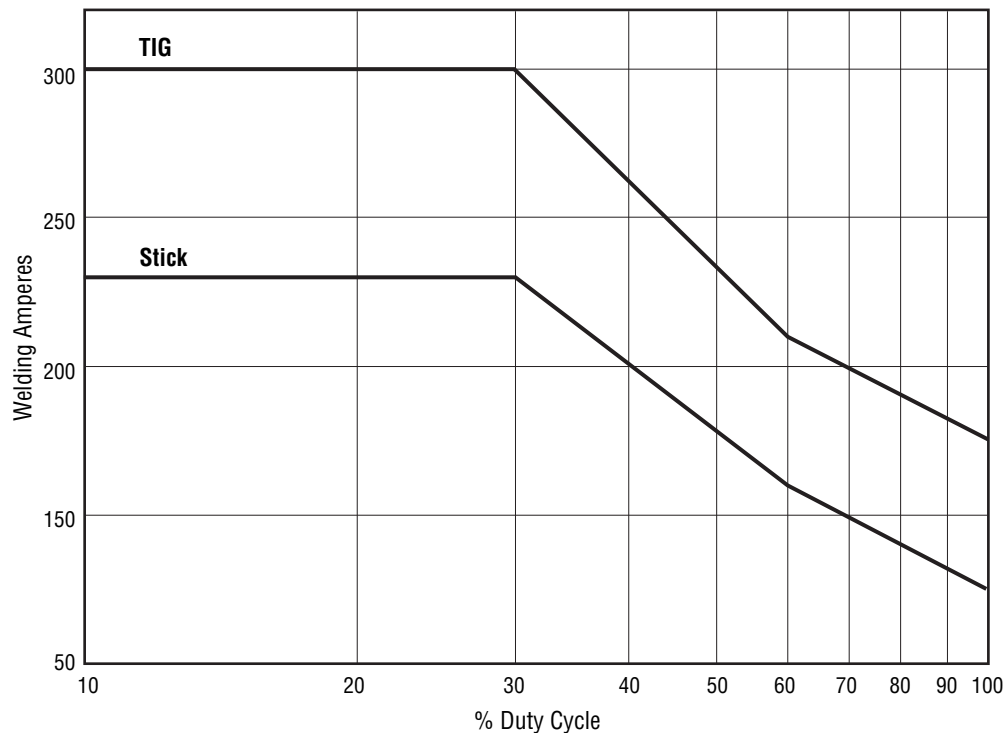

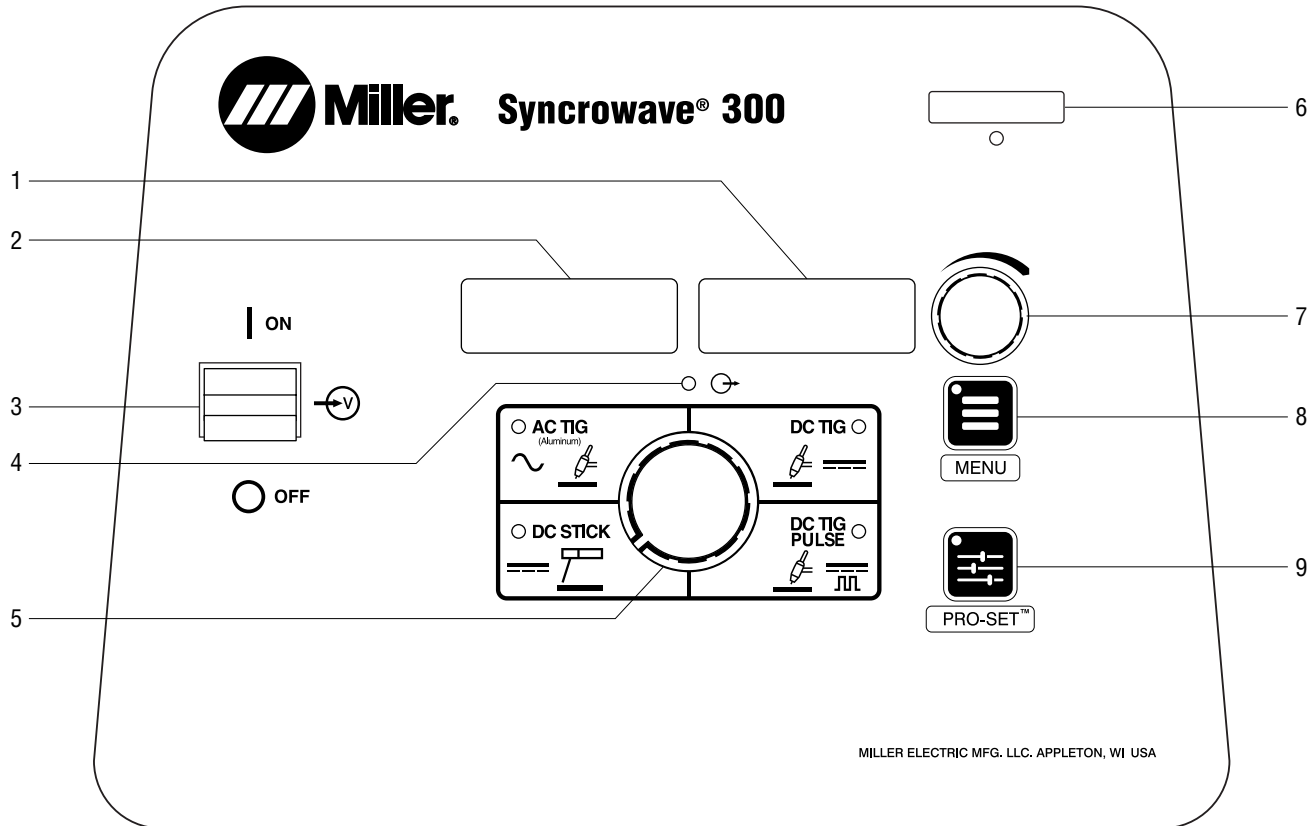

MILLER ELECTRIC MFG. LLC. APPLETON, WI USA

## 1. Ammeter

Displays actual amperage while welding and preset amperage while idle. It is also used to display parameter selection options while in the menu.

## 2. Voltmeter

Displays actual rectified average voltage when voltage is present at the weld output terminals. It is also used to display parameter descriptions while in the menu.

## 3. Main Power Switch

Use switch to turn machine on or off.

## 4. Output ON Indicator

Blue indicator illuminates when output is on.

## 5. Process Selector

**AC TIG** — Used for welding aluminum.

**DC TIG (DCEN)** — Used for welding mild and stainless steel.

**DC TIG Pulse (DCEN)** — Used for welding mild and stainless steel.

**DC Stick (DCEP)** — Used for welding steels.

## 6. Memory Card Port and Indicator

This port is used to add features to the machine and update software to the boards within the machine. Indicator is lit while card is being accessed.

## 7. Amperage Adjustment Control

Use control to change preset amperage value. If a remote control is used, preset amperage value is the maximum amperage output available. This control also functions as a parameter change control while in the menu mode.

## 8. Menu Button

Press button to scroll through available parameters for the selected process. Hold button to enter setup mode.

## 9. Pro-Set™ Button

Press button to lock in all parameters to factory settings while LED is lit. Press and hold for five seconds to reset all parameters to factory settings. Meter display counts down.

# Syncrowave® 300 Models/Packages

Machine only



## Syncrowave 300 machine only

907782 (208/240/480 V)  
*Input power plug NOT included.*

Syncrowave 300 Complete Package with wired foot control shown.



## Syncrowave 300 Complete packages

951829 (208/240/480 V)  
with wired foot control  
951830 (208/240/480 V)  
with wireless foot control

Completely assembled. Includes Syncrowave, Coolmate™ 3 cooler, running gear, RFCS-14 HD remote foot control **OR** wireless remote foot control, four gallons of TIG coolant, and a water-cooled torch kit consisting of Weldcraft™ W-280 TIG torch, torch consumables kit, cable cover, flowmeter regulator, gas hose, torch connector, and work clamp with cable and Dinse-style connector.

*Input power plug NOT included.*



# Genuine Miller® Accessories

## TIG Torch Kits and Connectors



**W-280 Water-Cooled Torch Kit 300990**  
Kit comes with Weldcraft™ W-280 (WP-280) 25-foot (7.6 m) TIG torch with Dinse-style connector, torch cable cover, work clamp with 15-foot (4.6 m) cable and Dinse-style connector, flowmeter regulator with gas hose and AK4GL gas lens torch accessory kit.

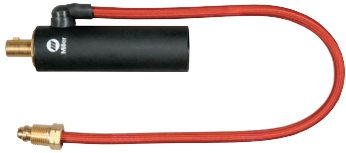

**Water-Cooled TIG Torch Connector 195377**  
50-mm Dinse-style with water return line. For use with all Weldcraft™ water-cooled torches.



**Air-Cooled TIG Torch Connector 195379**  
Used to adapt a Weldcraft™ A-200 (WP-26) torch to a Dinse-style connector.

## Remote Controls and Switches



**Wireless Remote Foot Control 300429**  
For remote current and contactor control. Receiver plugs directly into the 14-pin receptacle of Miller machine. 90-foot (27.4 m) operating range.



**Wireless Remote Hand Control 300430**  
For remote current and contactor control. Receiver plugs directly into the 14-pin receptacle of Miller machine. 300-foot (91.4 m) operating range.



**RFCS-14 HD Foot Control 194744**  
Maximum flexibility is accomplished with a reconfigurable cord that can exit the front, back or either side of the pedal. Foot pedal provides remote current and contactor control. Includes 20-foot (6 m) cord and 14-pin plug.



**RHC-14 Hand Control 242211020**  
Miniature hand control for remote current and contactor control. Dimensions: 4 x 4 x 3.25 inches (102 x 102 x 83 mm). Includes 20-foot (6 m) cord and 14-pin plug.



**RCCS-14 Remote Contactor and Current Control 043688**  
North/south rotary-motion fingertip control attaches to TIG torch using two hook-and-loop fasteners. Includes 26.5-foot (8 m) cord and 14-pin plug.



**RCC-14 Remote Contactor and Current Control 151086**  
East/west rotary-motion fingertip control attaches to TIG torch using two hook-and-loop fasteners. Includes 26.5-foot (8 m) cord and 14-pin plug.



**RMLS-14 Switch 129337**  
Momentary- and maintained-contact rocker switch for contactor control. Push forward for maintained contact and backward for momentary contact. Includes 26.5-foot (8 m) cord and 14-pin plug.



**RMS-14 On/Off Control 187208**  
Momentary-contact switch for contactor control. Rubber-covered pushbutton dome switch ideal for repetitive on-off applications. Includes 26.5-foot (8 m) cord and 14-pin plug.

**Extension Cables for 14-Pin Remote Controls**  
242208025 25 ft. (7.6 m)  
242208050 50 ft. (15.2 m)  
242208080 80 ft. (24.4 m)

## Genuine Miller® Accessories (continued)

### Coolant



#### Low-Conductivity Coolant 043810

Sold in cases of four one-gallon recyclable plastic bottles. Miller coolants contain a base of ethylene glycol and deionized water to protect against freezing to -37 degrees Fahrenheit (-38°C) or boiling to 227 degrees Fahrenheit (108°C). Also contains a compound that resists algae growth.

### TIG Welding Gloves



#### Performance TIG Gloves

**263346** Small

**263347** Medium

**263348** Large

**263349** X-Large

Completely unlined, goat grain leather with triple-padded palm.

### Educational Materials

To order, please call Miller Literature at 866-931-9732 or visit [MillerWelds.com/resources/tools](http://MillerWelds.com/resources/tools).

**Gas Tungsten Arc Welding (TIG) Publication 250833**

## Tungsten

Tungsten	Amp Range	2% Ceriated (AC/DC)	2% Lanthanated (AC/DC)
1/16 in. (1.6 mm)	70–150 A	WC116X7	WL2116X7
3/32 in. (2.4 mm)	140–250 A	WC332X7	WL2332X7
1/8 in. (3.2 mm)	225–400 A	WC018X7	WL2018X7
5/32 in. (4.0 mm)	300–500 A	WC532X7	WL2532X7

## Ordering Information

Equipment and Options	Stock No.	Description	Qty.	Price
<b>Syncrowave® 300</b>	<b>907782</b>	208/240/480 V, 50/60 Hz		
<b>Syncrowave® 300 Complete with Wired Foot Control</b>	<b>951829</b>	208/240/480 V, 50/60 Hz		
<b>Syncrowave® 300 Complete with Wireless Foot Control</b>	<b>951830</b>	208/240/480 V, 50/60 Hz		
<b>TIG Torch Kits and Connectors</b>				
W-280 Water-Cooled Torch Kit	<b>300990</b>	See page 6 for contents		
Water-Cooled TIG Torch Connector	<b>195377</b>	Connects Weldcraft™ water-cooled torches to Dinse-style connector		
Air-Cooled TIG Torch Connector	<b>195379</b>	Connects Weldcraft™ A-200 (WP-26) torch to Dinse-style connector		
Tungsten		See page 7		
<b>Remote Controls</b>				
Wireless Remote Foot Control	<b>300429</b>	Foot control with wireless 90 ft. (27.4 m) operating range		
Wireless Remote Hand Control	<b>300430</b>	Hand control with wireless 300 ft. (91.4 m) operating range		
RFCS-14 HD	<b>194744</b>	Heavy-duty foot control		
RHC-14	<b>242211020</b>	Hand control		
RCCS-14	<b>043688</b>	North/south fingertip control		
RCC-14	<b>151086</b>	East/west fingertip control		
RMLS-14	<b>129337</b>	Momentary/maintained rocker switch		
RMS-14	<b>187208</b>	Momentary rubber dome switch		
Extension Cables		See page 6		
<b>Accessories</b>				
TIG Coolant (Must be ordered in quantities of four)	<b>043810</b>	1-gallon plastic bottle. Protects against freezing to -37° Fahrenheit (-38°C) or boiling to 227° Fahrenheit (108°C)		
TIG Welding Gloves		See page 7		
Cable Connectors		<i>Supplied with power source and torch kits</i>		
Dinse-Style Connector 50 mm (1 male)	<b>042418</b>	Used to connect weld lead to Dinse terminal machine		
Dinse-Style Connector 50 mm (1 male, 1 female)	<b>042419</b>	Used to extend weld cables		
Dinse/Tweco® Adapter	<b>042465</b>	Male Dinse-style to female Tweco		
Dinse/Cam-Lok Adapter	<b>042466</b>	Male Dinse-style to female Cam-Lok		
Gas Tungsten Arc Welding (TIG) Publication	<b>250833</b>			

Date:

Total Quoted Price:

Distributed by:

